

FEATURES and FUNCTIONAL DIAGRAM

- Bipolar technology
- Reverse battery protection
- 3.5V to 30V Operation voltage
- -40 °C to 150 °C Superior temperature operation
- Open-collector 20 mA output
- Small Size SOT-23, SOT-89 or TO-92S
- Solid-state reliability
- Resistant to physical stress
- Activate with small, commercially available permanent magnets

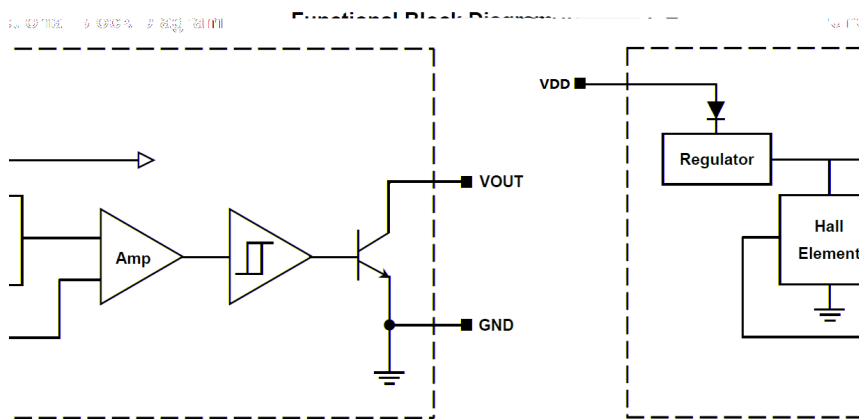

PACKAGE

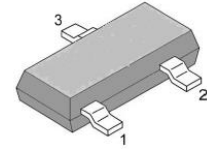

SOT-23

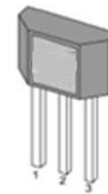

TO-92

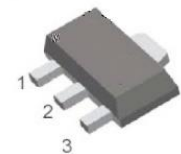

SOT-89

APPLICATIONS

- Brushless DC motor commutation
- Automotive, Consumer and Industrial
- Solid-state switch
- Speed measurement
- Revolution counting
- Angular position detection
- Magnetic Encoder

DESCRIPTION

The CH411 family is a Hall-effect latch designed in bipolar technology. The Hall IC internally includes an on-chip Hall voltage generator, a voltage regulator for operation with supply voltages of 3.5 to 30V, reverse protection diode, temperature compensation circuitry, small-signal amplifier, Schmitt trigger and an output driver; all in a single package.

It is designed to respond to alternating North and South poles. While the magnetic flux density(B) is larger than operate point (Bop), the output will be turned on (Low), the output is held until the magnetic flux density(B) is lower than release point (Brp), then be turned off (High).

Thanks to its wide operating voltage range 3.5 to 30V and extended temperature range from -40 to +150 , it is quite suitable for use in automotive, industrial and consumer applications.

The device is delivered in variety of packages to customers: SOT-23, SOT-89 for surface mount and TO-92S flat for through-hole mount. Both 3-lead packages are RoHS compliant.

Table of Contents

1. Glossary of Terms	3
2. Product Family Members	3
3. Pin Definitions and Descriptions.....	3
4. Absolute Maximum Ratings	4
5. ESD protections	4
6. Function Description.....	4
7. Definition of Switching Function	5
8. CH411 Series Parameters Specification	5
9. Test Conditions	6
10. Typical Application Circuit	6
11. Typical Output Waveform.....	6
12. Package Information	7

1. Glossary of Terms

MilliTesla (mT),	Gauss Units of magnetic flux density: 1mT = 10 Gauss
RoHS	Restriction of Hazardous Substances
ESD	Electro-Static Discharge
BLDC	Brush-Less Direct-Current
Operating Point (B_{OP})	Magnetic flux density applied on the branded side of the package which turns the output driver ON ($V_{OUT} = \text{low}$)
Release Point (B_{RP})	Magnetic flux density applied on the branded side of the package which turns the output driver OFF ($V_{OUT} = \text{high}$)

2. Product Family Members

Part Number	Marking ID	Description
CH411SR	C411	Bipolar latching, Hall-effect digital sensor IC, SOT-23-3L package, tape and reel packing (3000 units per reel)
CH411TB	C411	Bipolar latching, Hall-effect digital sensor IC, flat, TO-92S package, bulk packing (1000 units per bag)
CH411ER	C411	Bipolar latching, Hall-effect digital sensor IC, SOT-89-3L package, tape and reel packing (1000 units per reel)

3. Pin Definitions and Descriptions

SOT-23 (AT and ET)	TO-92S (A and A-T)	SOT-89 (BT)	Name	Type	Function
1	1	1	VDD	Supply	Supply Voltage pin
2	3	3	OUT	Output	Open Collector Output pin
3	2	2	GND	Ground	Ground pin

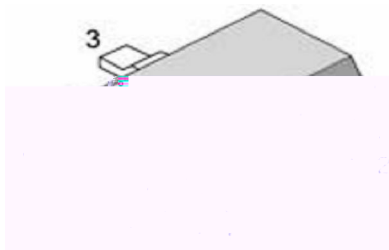

SOT-23-3L

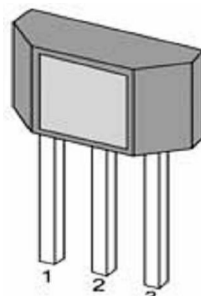

TO-92S

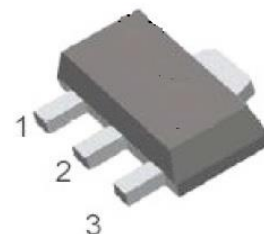

SOT-89-3L

4. Absolute Maximum Ratings

Parameter	Symbol	Min	Max	Units
Supply Voltage	VDD	-	40	V
Reverse Voltage	VRDD	-	-40	V
Supply Current	IDD	-	50	mA
Output Voltage	VOUT	-0.3	40	V
Output Current	IOUT	-	50	mA
Operating Ambient temperature	TA	-40	150	°C
Storage Temperature	TS	-50	150	°C
Junction temperature	TJ		165	°C
Magnetic Flux	No Limit			Gauss

Note: Exceeding the absolute maximum ratings may cause permanent damage. Exposure to absolute-maximum-rated conditions for extended periods may affect device reliability. ESD Protection

5. ESD protections

Parameter	Value	Unit
All pins ¹⁾	+/-2	kV
All pins ²⁾	+/-200	V

1) HBM (human body model, 100pF, 1.5 kohm) according to MIL 883C, Method 3015.7 or EIA/JESD22A114-A

2) acc. Machine Model: C=200pF; R=0 Ω

6. Function Description

The CH411 exhibits latch magnetic switching characteristics. Therefore, it requires both south and north poles to operate properly.

The device behaves as a latch with symmetric operating and release switching points ($BOP=|BRP|$). This means magnetic fields with equivalent strength and opposite direction drive the output high and low.

Removing the magnetic field ($B = 0$) keeps the output in its previous state. This latching property defines the device as a magnetic memory.

A magnetic hysteresis BHYST keeps BOP and BRP separated by a minimal value. This hysteresis prevents output oscillation near the switching point.

7. Temperature Characteristics

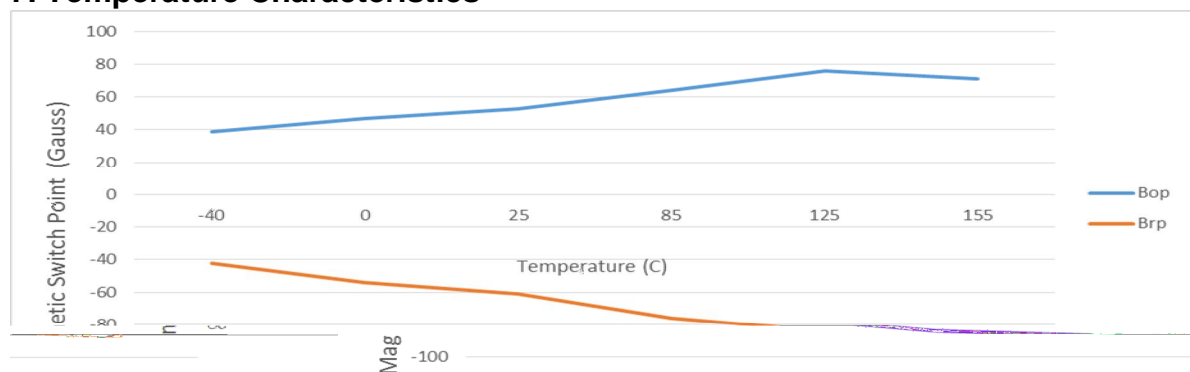

8. Definition of Switching Function

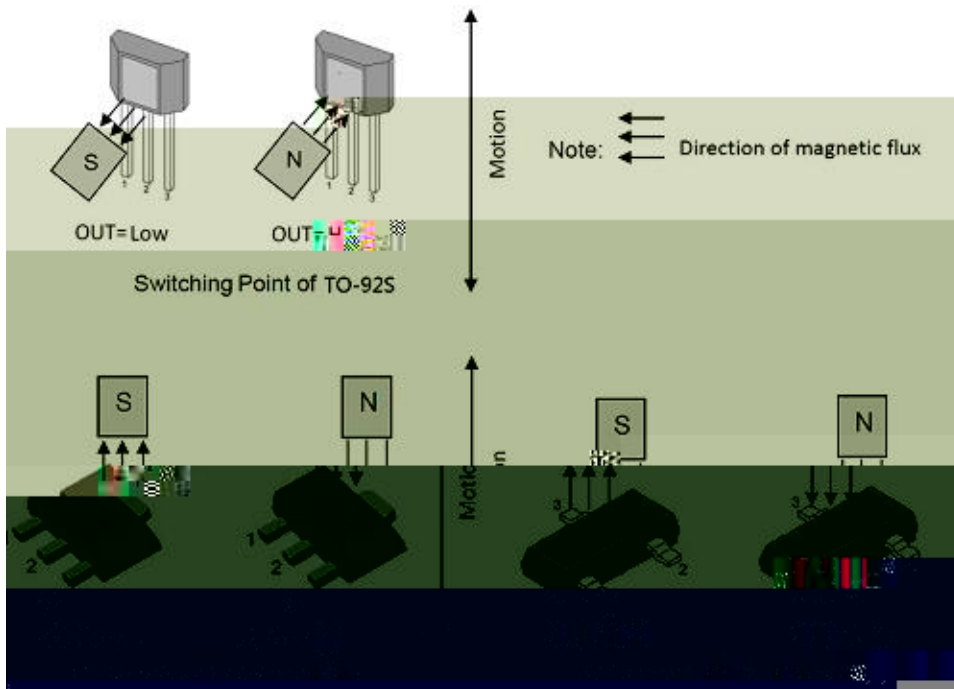
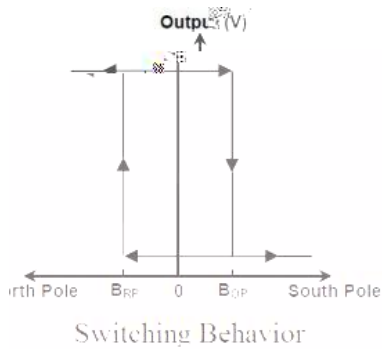

9. CH411 Parameters Specification

The voltages are referred to GND.

3.5V < VDD < 30V; T_J = -40 to 150°C, unless otherwise specified.

Symbol	Parameter	Test Condition	Min	Typ	Max	Units
VDD	Supply voltage	Operating	3.5	5	30	V
IDD	Supply Current	B < B _{RP}		4.0	9	mA
VDSon	Output saturation voltage	I _{out} = 15mA, B > B _{OP}			0.4	V
I _{OFF}	Output Leakage Current	B < B _{RP} , V _{OUT} = 30V			10	uA
T _R	Output rise time	R _L = 1Kohm, C _L = 20pF			1.5	uS
T _F	Output fall time	R _L = 1Kohm, C _L = 20pF			1.5	uS
F _{SW}	Maximum Switching Frequency				100	KHz
B _{OP}	Magnetic operating point	T _A = 25°C	5	50	100	Gauss
B _{RP}	Magnetic release point	T _A = 25°C	-100	-50	-5	Gauss
B _{HYST}	Magnetic hysteresis window	T _A = 25°C B _{OP} - B _{RP}	60	100	140	Gauss

10. Test Conditions

Note : DUT = Device Under Test

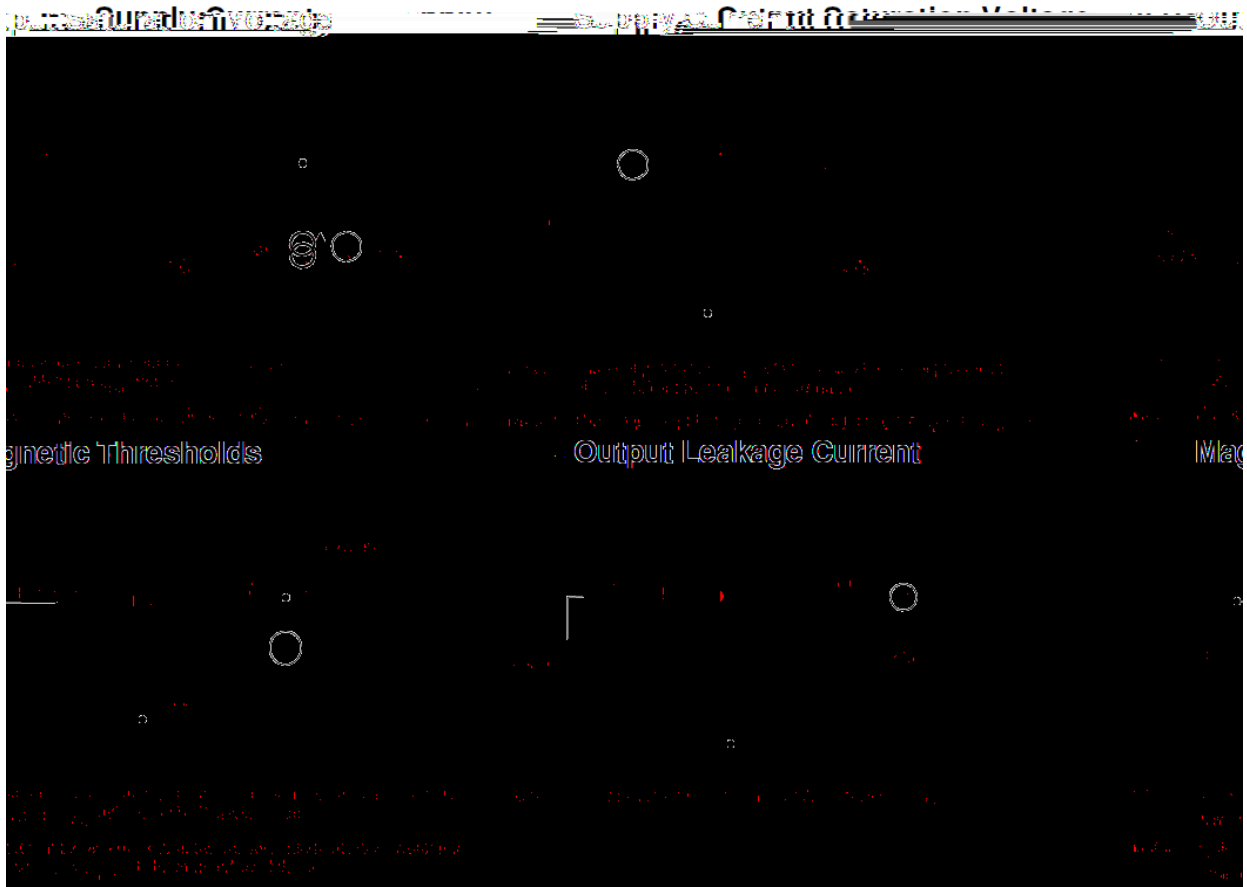

11. Typical Application Circuit

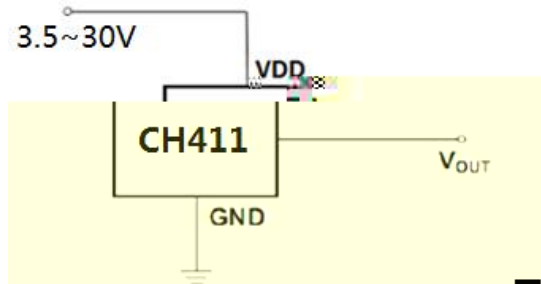

12. Typical Output Waveform (The TO-92S package as an example)

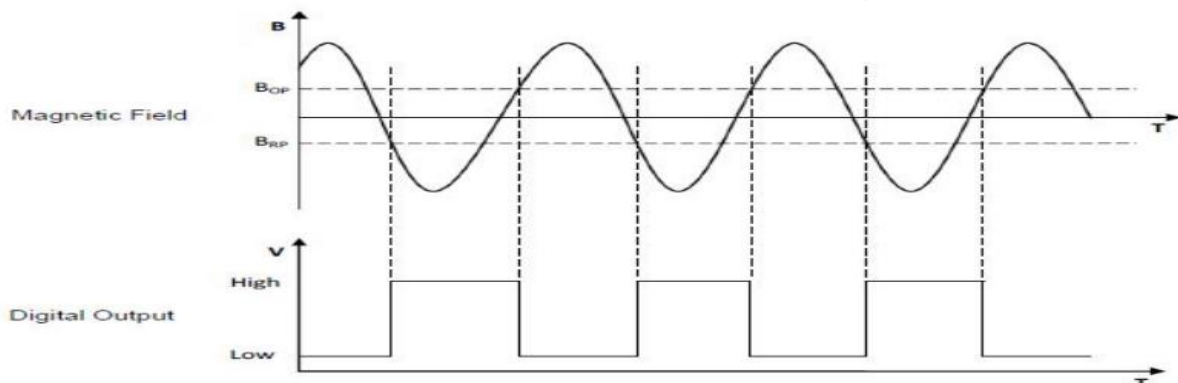

13. Package Information:

Symbol	Parameter	Test Condition	Min	Typ	Max	Units
RTH	SOT-23 Package Thermal Resistance			301		°C/W
	TO-92S Package Thermal Resistance			230		°C/W
	SOT-89 Package Thermal Resistance			230		°C/W

PACKAGE DESIGNATOR TO-92S

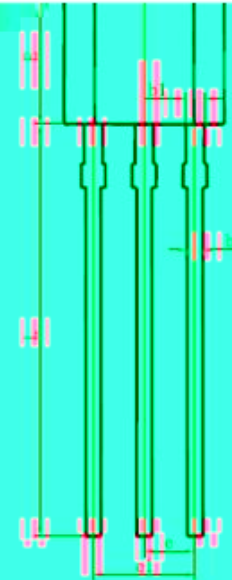
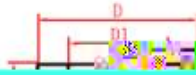
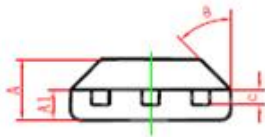

Dimensions In Millimeters	Dimensions In Inches	
	Min.	Max.
1.620	0.056	0.064
0.860	0.026	0.034
0.430	0.014	0.019
0.530	0.016	0.022
0.340	0.014	0.020
4.100	0.154	0.161
2.400	0.090	0.106
3.250	0.120	0.128
1.270 TYP.	0.050 TYP.	
2.640	0.096	0.104

Symbol	Dimension
	Min.
A	1.420
A1	0.660
b	0.350
b1	0.400
c	0.360
D	3.900
D1	2.280
E	3.050
e	
e1	2.440
L	15.130

PACK

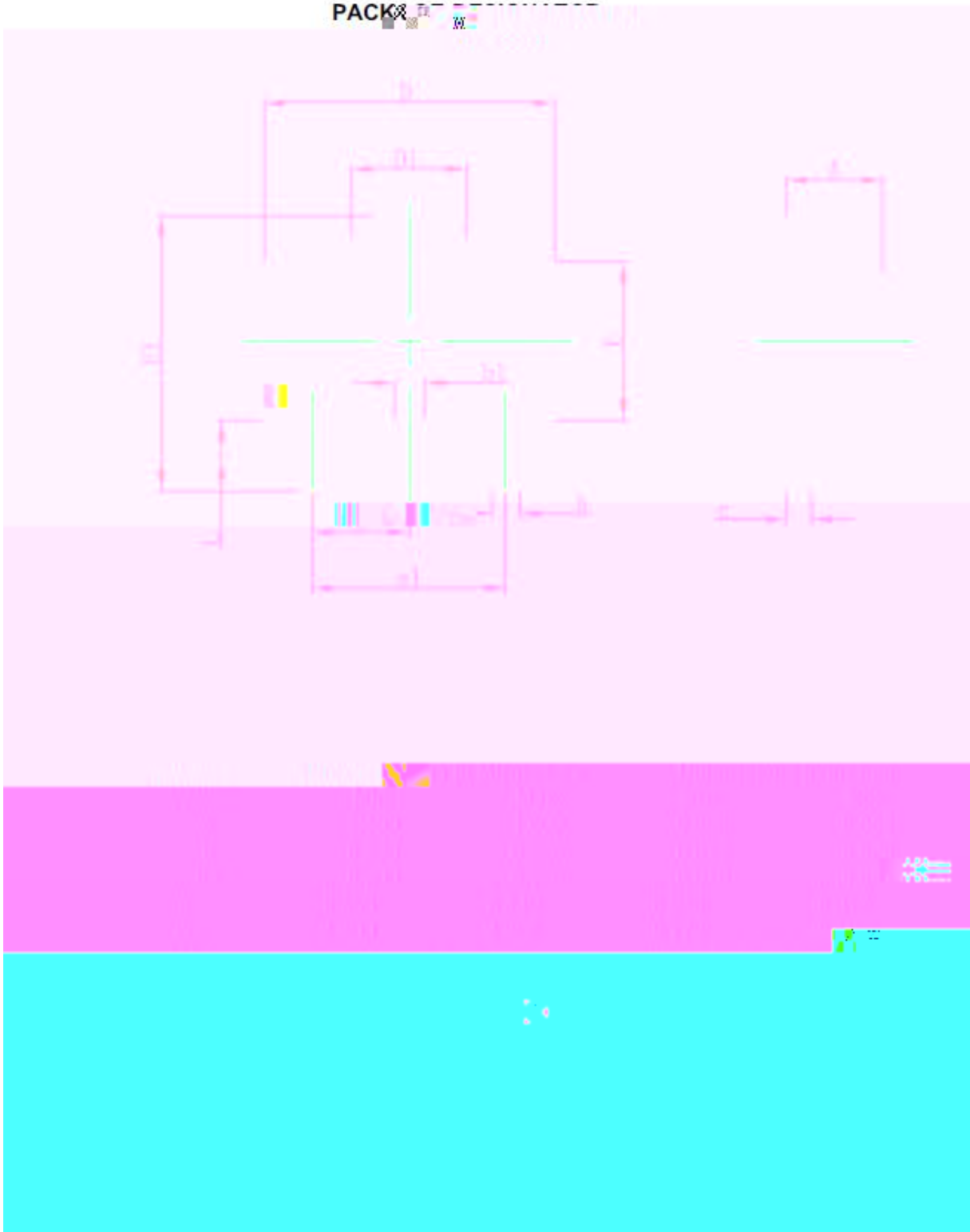

PACM 2

